

PRODUCT DESCRIPTION

BrightLine smart light box displays feature swift tool-free installation, durable light-weight frames, embedded LEDs, and exclusive One Planet recycled fabrics with impressive vivid graphics, all conveniently organized in a heavy-duty shipping case. Panel M boosts two meters of illuminated allure, perfect to create 20 ft displays that fit in just three cases.

Mix-and-match with other BrightLine panels, or combine with WaveLine and SharpLine displays, to create unique branded environments. TV mounts and counters complete an enhanced experience to really make brands stand out.

KEY FEATURES

- Easy tool free assembly
- Lightweight portable construction
- Magnetic power links
- LED lights encapsulated in frame
- Heavy duty shipping case, molded foam inserts
- Single- or double-sided
- Vibrant graphics on recycled fabric

DISPLAY CONSTRUCTION

Aluminum frame with aluminum support poles

DIMENSIONS

Assembled Unit	79"w x 96"h x 4"d
Packed Case	46.5"w x 15"h x 12"d, 58 lbs
Shipping Box	47"w x 16"h x 13"d, 60 lbs
Graphic Size	79"w x 96"h

GRAPHIC MATERIAL

Graphic Print : Dye sublimated on One Planet, 100% recycled, backlit fabric	Bottles recycled 55
Blocker : One Planet light block recycled fabric	Bottles recycled 22

LED LIGHT SPECIFICATIONS

Power Requirements	128 W
CCT (Color Temp)	6000 K
Voltage Input	110 / 220V
Voltage Output	24V 11A 264W
Transformers Included	1

GRAPHIC FINISHING

Silicone sewn edges

WARRANTY

Limited Warranty Periods

- Frame : Lifetime
- Lights : 90 days
- Graphics : 30 days

PARTS

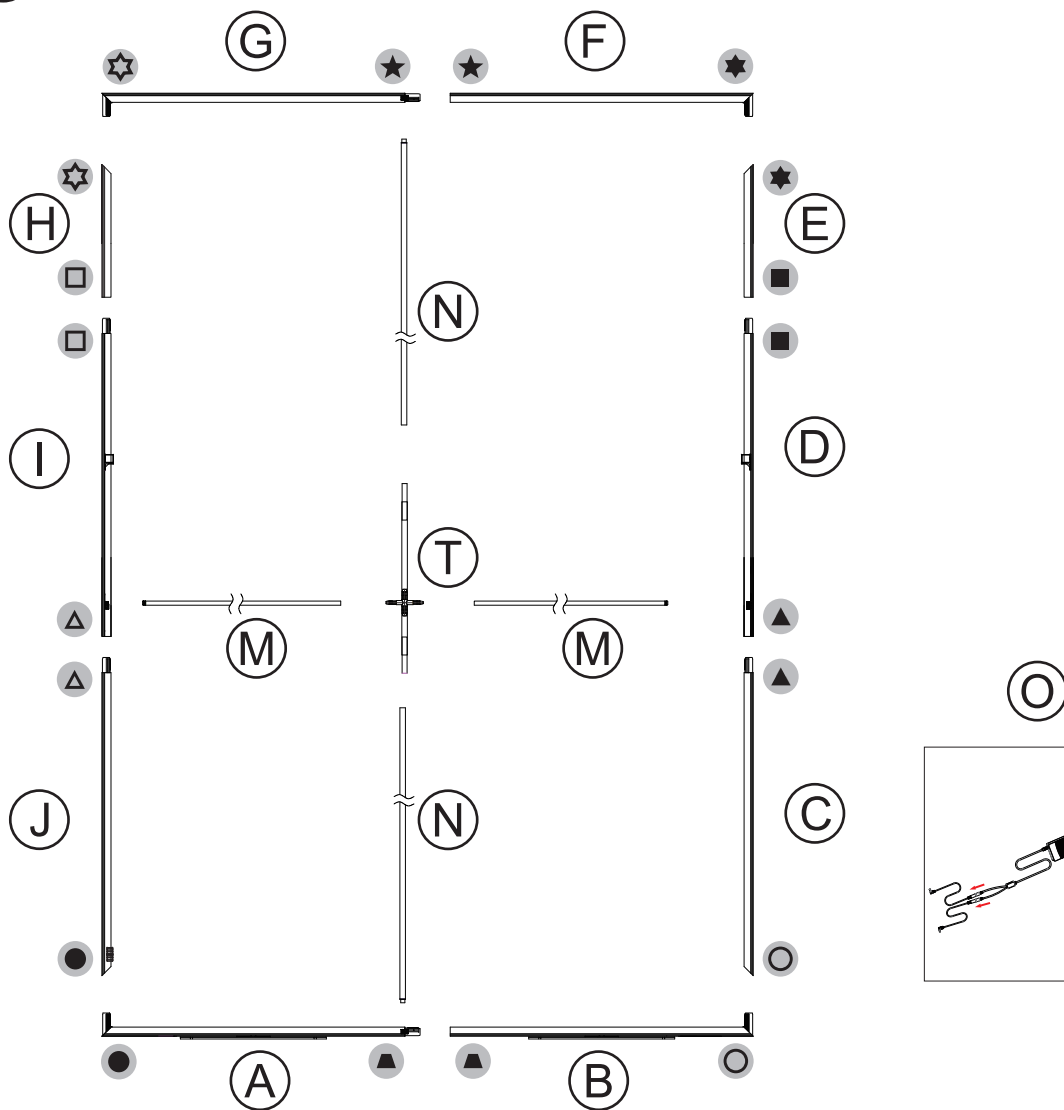
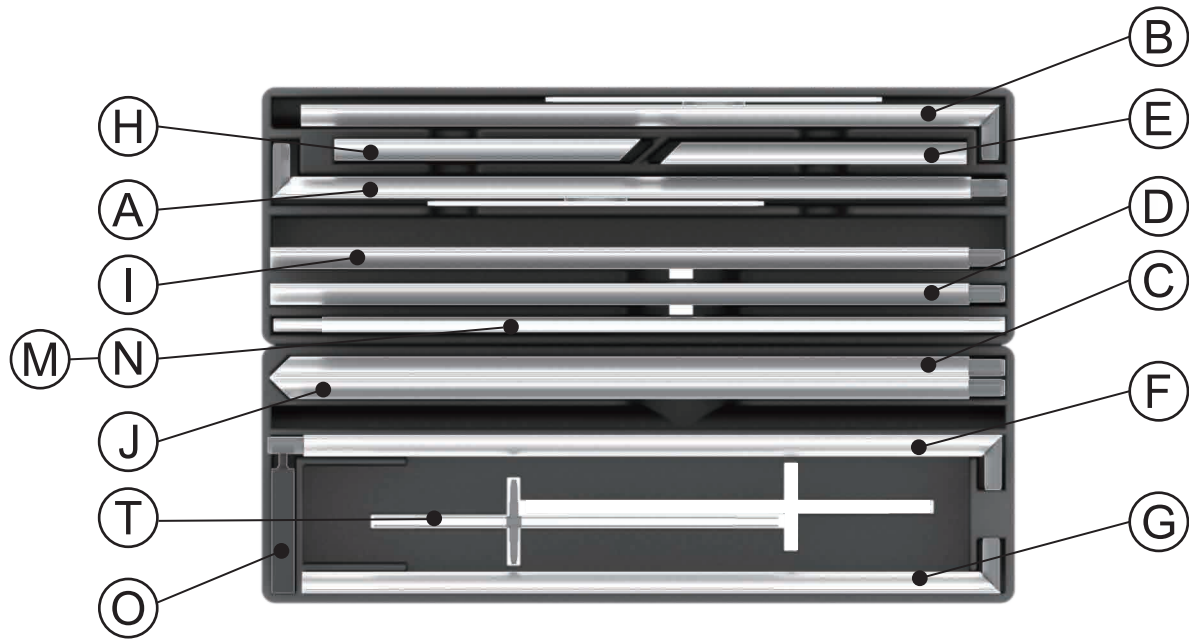

ASSEMBLY

Assemble parts on the floor and stand-up unit when completed.

1

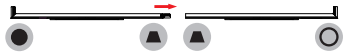
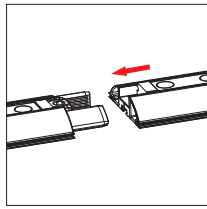

2

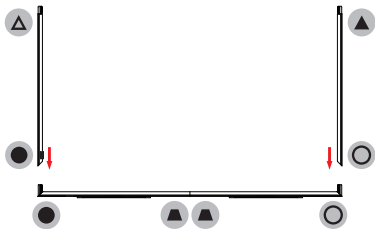
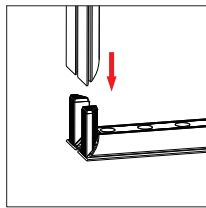

3

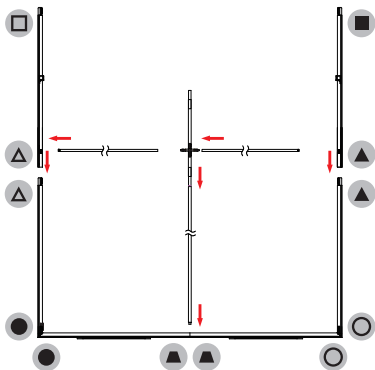
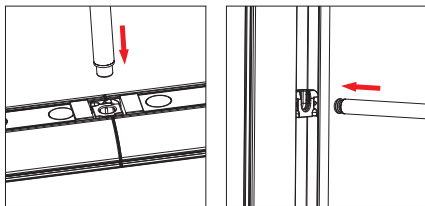

4

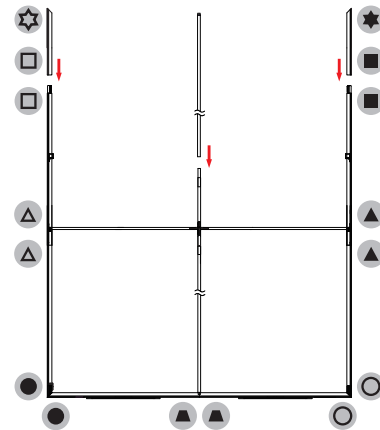
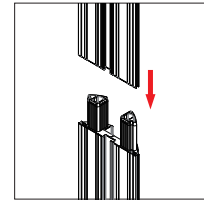

5

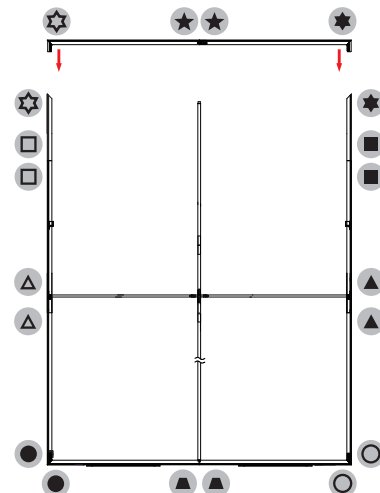
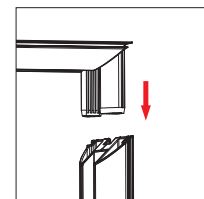

- 6 Push the silicone bead into each corner of the frame with your thumb.

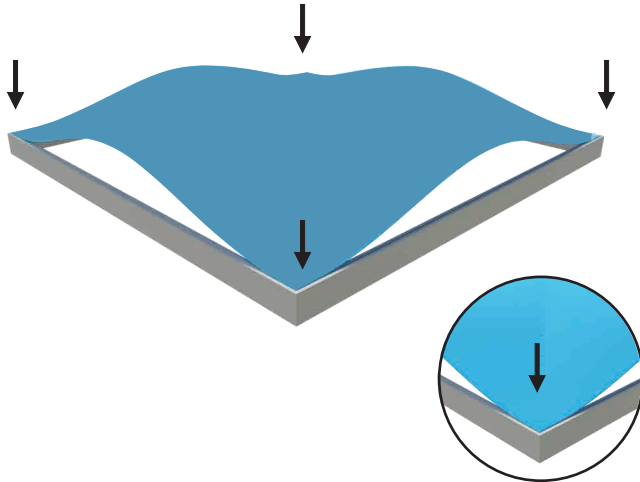

Push the silicone bead into the middle of the run and work your way around the perimeter of the frame until all beading is pushed in properly

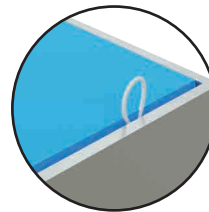
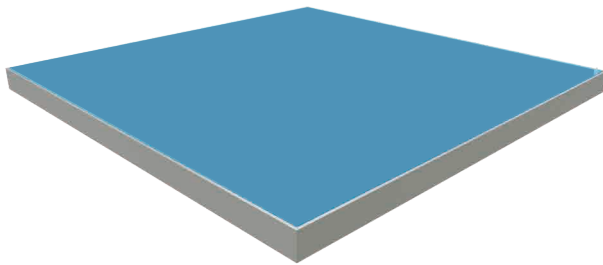
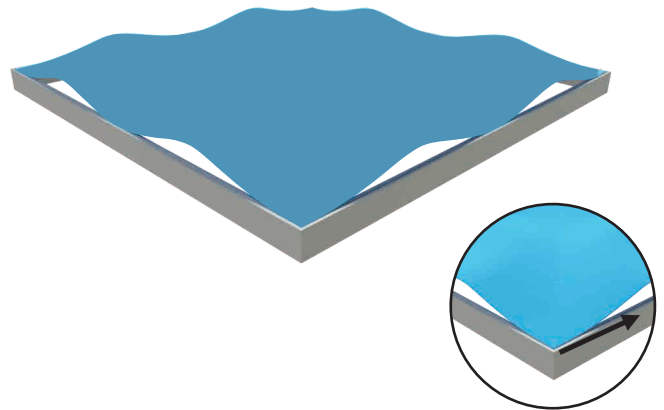

To Remove Graphic
Use the pull tab located on the graphic and gently pull the graphic from the frame, going around the perimeter

- 7

