

# LIGHT FRAME

## SET UP INSTRUCTION

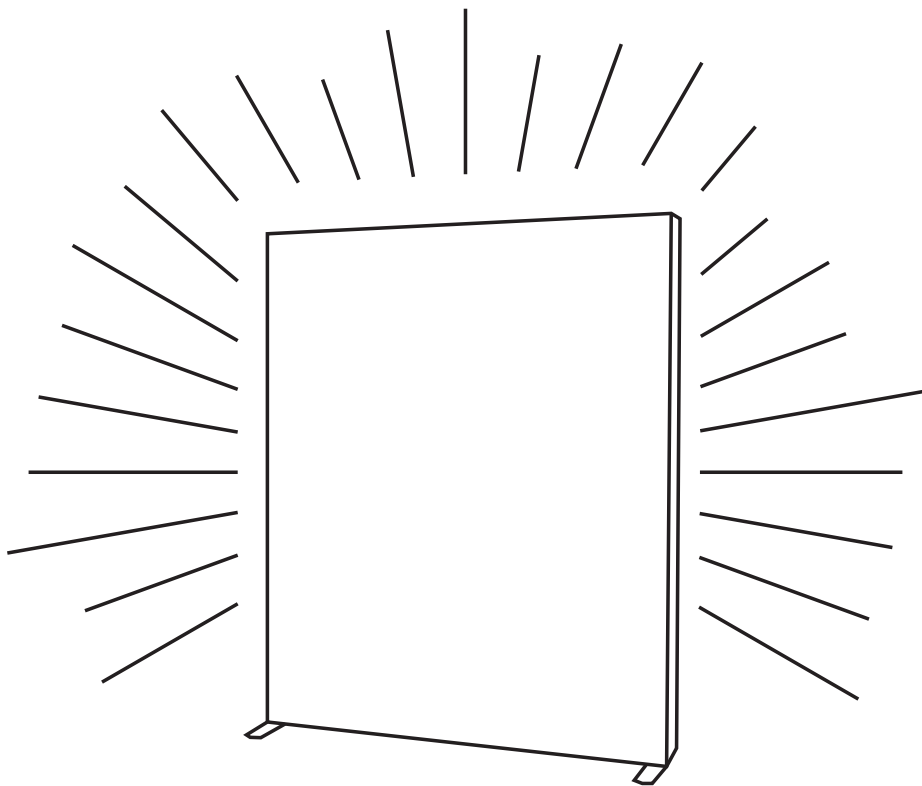

Safety tested and approved by Intertek according to:  
European Union Standards (CE):

IEC 60598-2-1:1979+A1, EN 60598-1:2015+A1, EN 60598-2-1:1989, IEC 60598-1:2014(AMD1):2017, IEC 62031  
IEC 62471:2006

RECOGNIZED  
COMPONENT



Intertek

Safety tested and approved by Intertek according to:

North American Standards (ETL):  
CSA C22.2#250.0:2018 Ed.4, UL 153:2014 Ed13+R:27.Jul2018

**0,96x2,5**

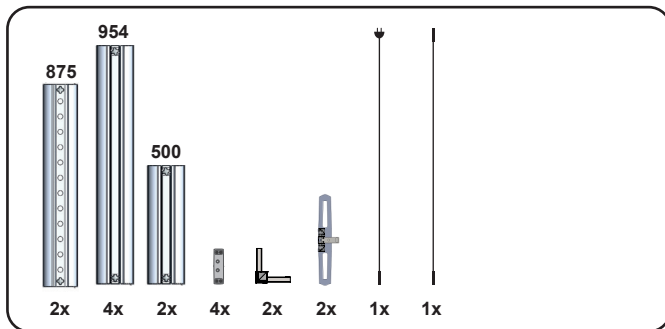

**1,96x2,5**

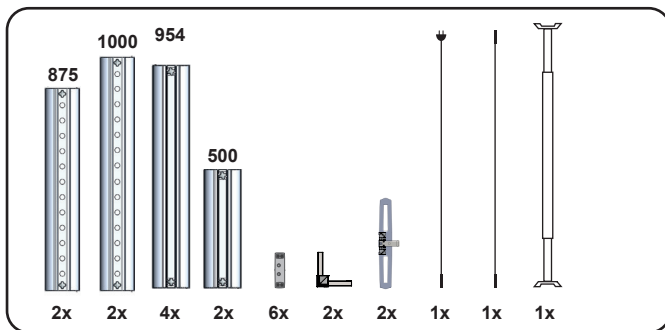

**2,96x2,5**

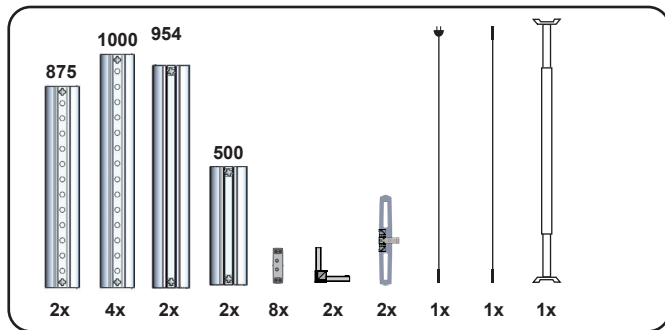

**3,96x2,5**

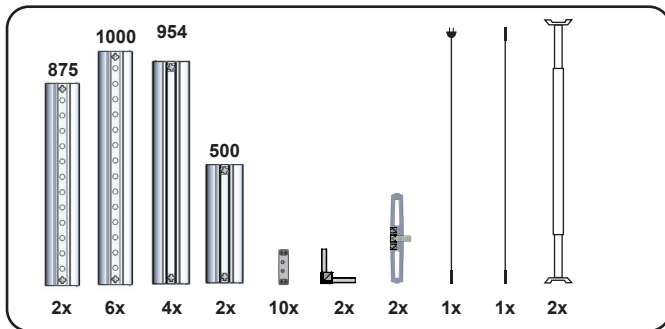



Max. frame width 5 meters, max. input power 500 W

1.

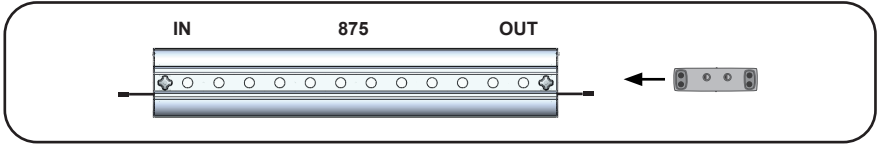

2.

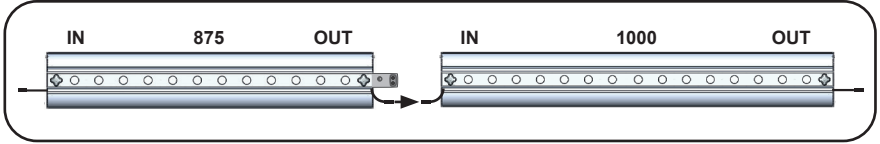

3.

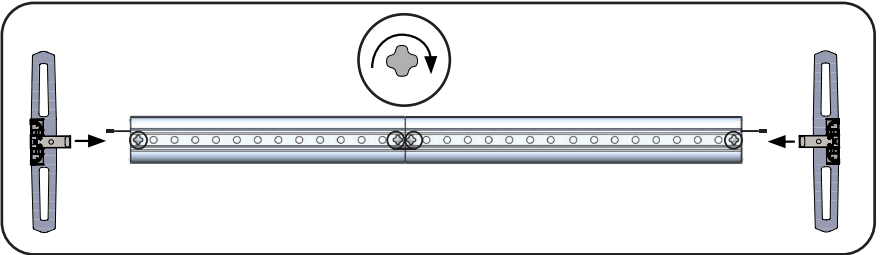

4.

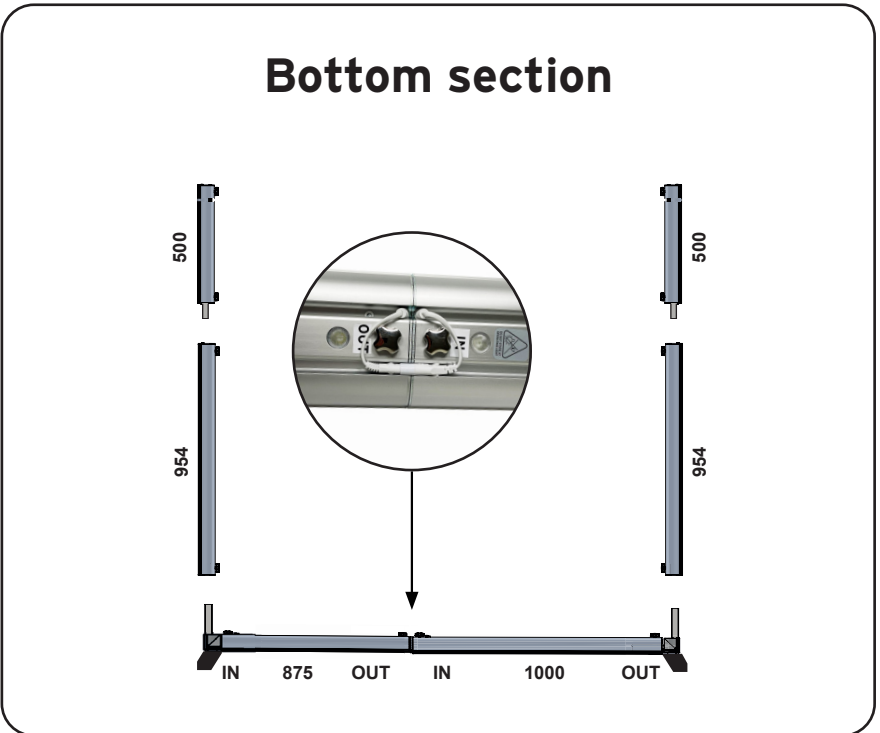

5.

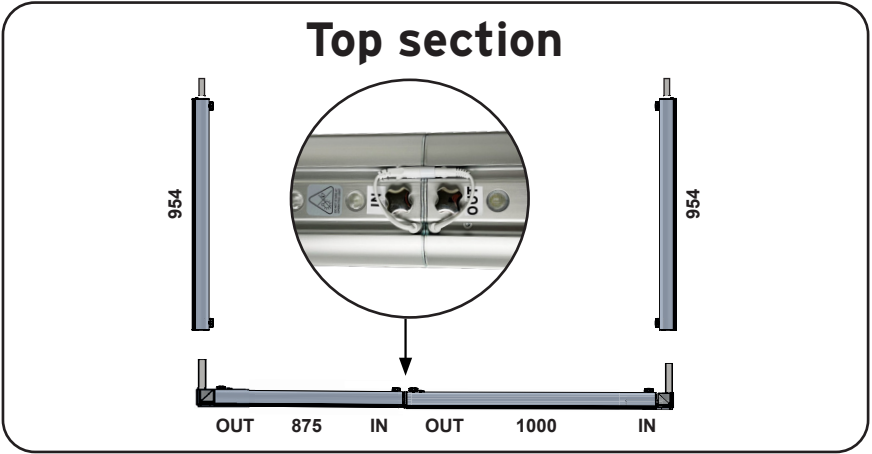

6.

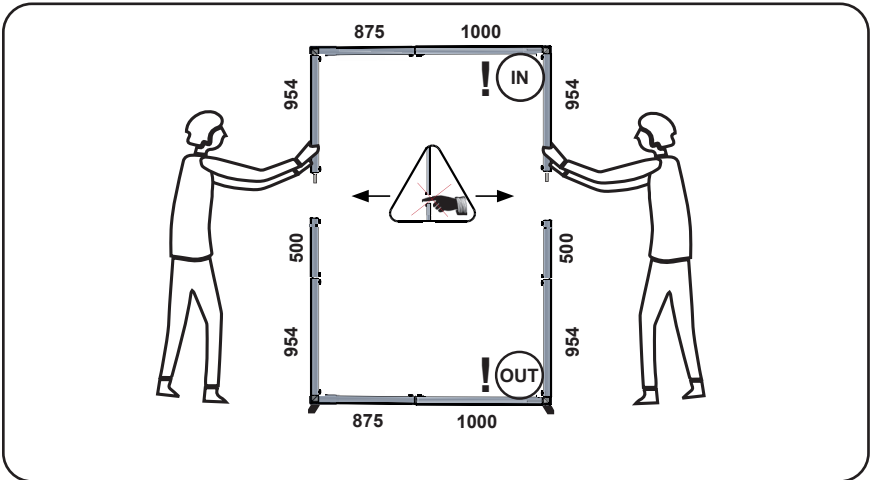

7.

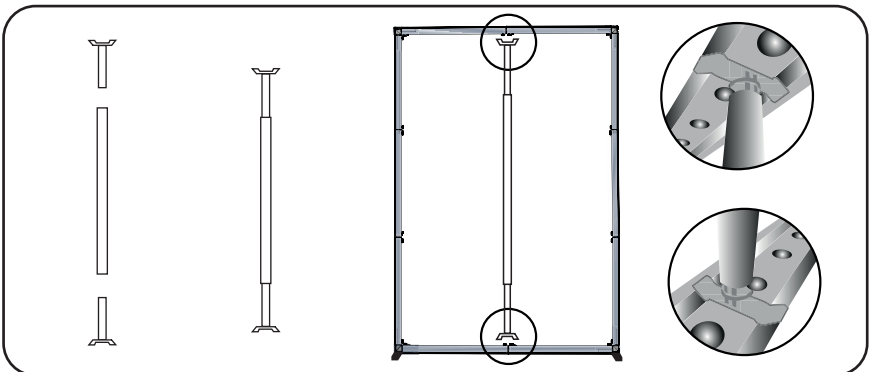

8.

- For indoor use only.

- The luminaire should be positioned so that prolonged staring into the luminaire at a distance closer than 1.58 m is not expected.

- If the external flexible cable or cord of this luminaire is damaged, it shall be exclusively replaced by the manufacturer or his service agent or a similar qualified person in order to avoid a hazard.

- The light source of this luminaire is not replaceable; when the light source reaches its end of life the whole luminaire shall be replaced.



9.

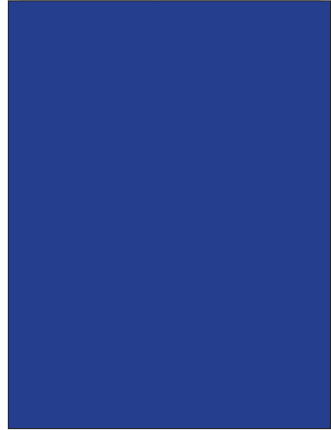
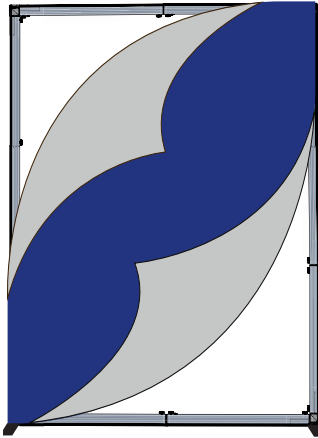
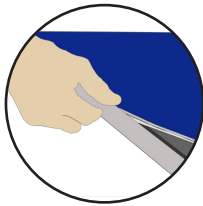

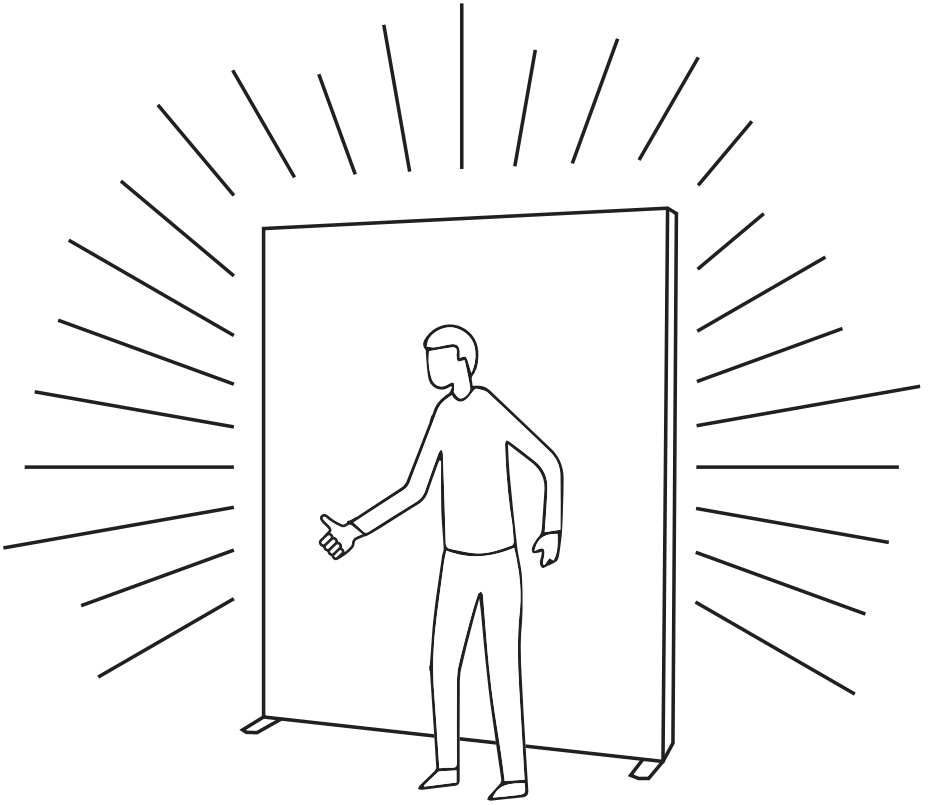

# Connectors

## Connectors - Classic Frame - Light Frame

Straight Type A

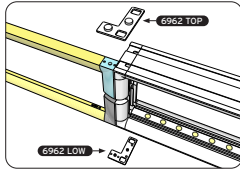

Straight Type B

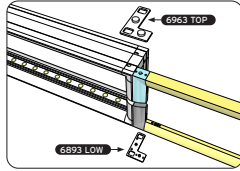

90° Type A

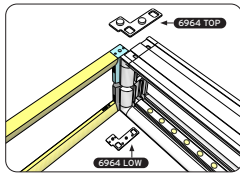

90° Type B

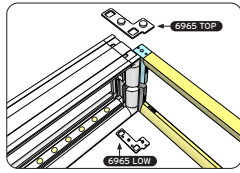

## Connectors - Light Frame - Light Frame

Straight

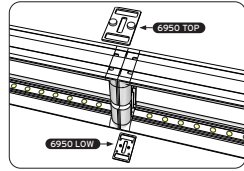

90°

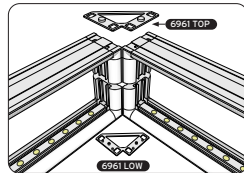

# Stabilizing feet

## Connecting feet - Classic Frame/Light Frame

Double-sided (Standard)

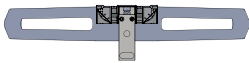

Single-sided (Optional)

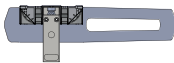

Straight Type B

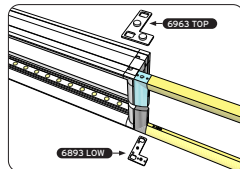

Straight Type A with double sided supporting foot

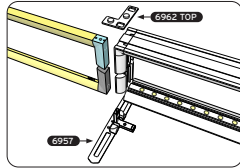

Straight Type B with single sided supporting foot

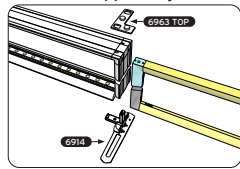

## Connecting feet - Light Frame - Light Frame

Straight with double sided connection foot

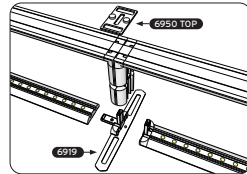

Straight with single sided connection foot

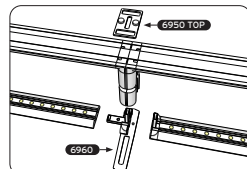



# We create marketing tools for professionals

HIGH PERFORMANCE  
DISPLAY SYSTEMS

EXPOLINC.COM



Safety tested and approved by Intertek according to:

European Union Standards (CE):

IEC 60598-2-1:1979+A1, EN 60598-1:2015+A1, EN 60598-2-1:1989, IEC 60598-1:2014(AMD1:2017, IEC 62031  
IEC 62471:2006



C

Intertek

Safety tested and approved by Intertek according to:

North American Standards (ETL):

CSA C22.2#250.0:2018 Ed.4, UL 153:2014 Ed13+R:27.Jul2018