

# SET UP INSTRUCTION

## Expolinc Frame



Watch the setup movie!

### BASIC SET UP

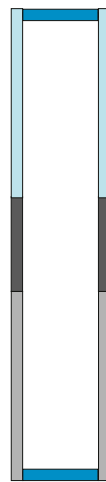
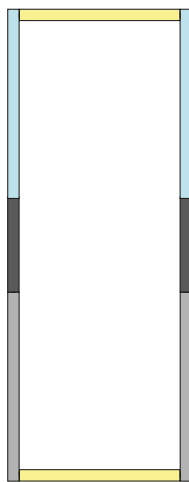
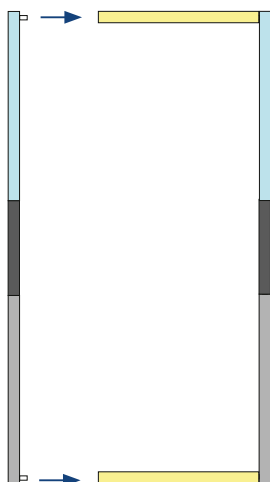
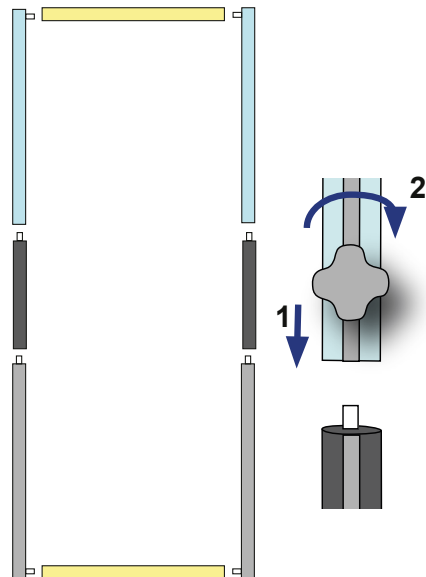
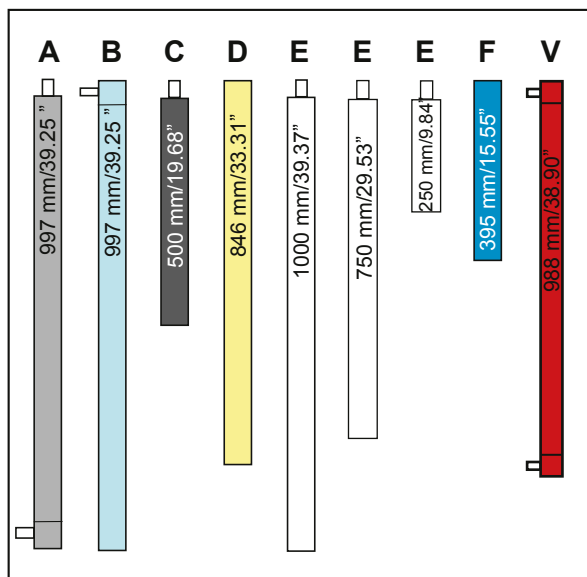

# WIDTHS & HEIGHTS

-   250 mm/9.84"
- 500 mm/19.68"
- 750 mm/29.52"
- 1000 mm/39.37"

500x1995 mm  
19,7x78,5"

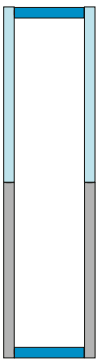

1950x1995 mm  
76,8x78,5"

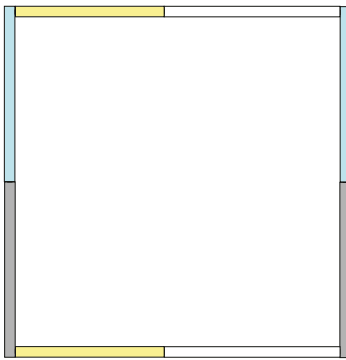

2450x2995 mm  
96,5x117,9"

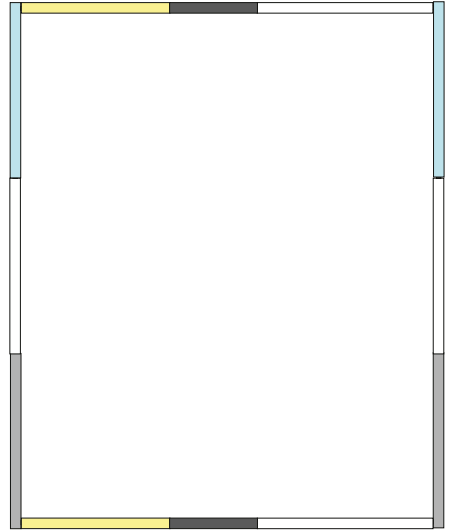

2950x2450 mm  
116,1x96,45"

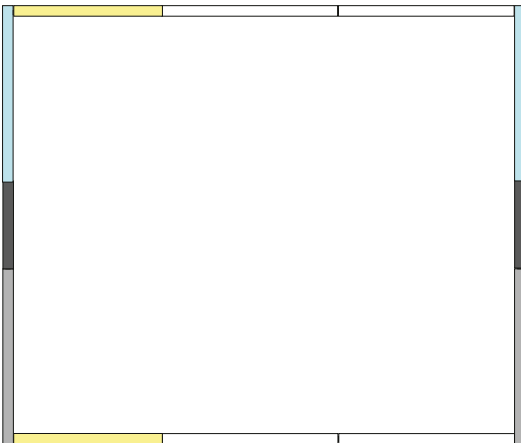

500x988 mm  
19,67x38,88"

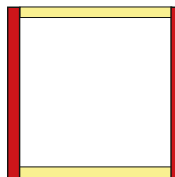

## SUPPORTING ROD

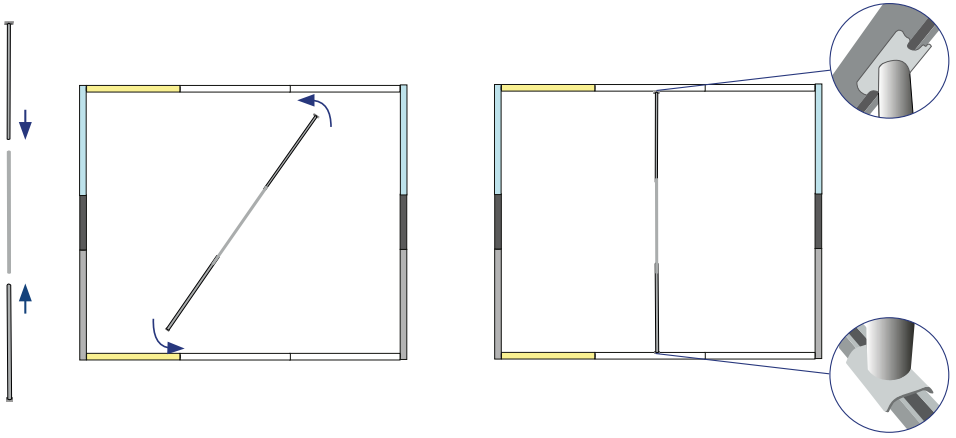

## MOUNT THE GRAPHIC

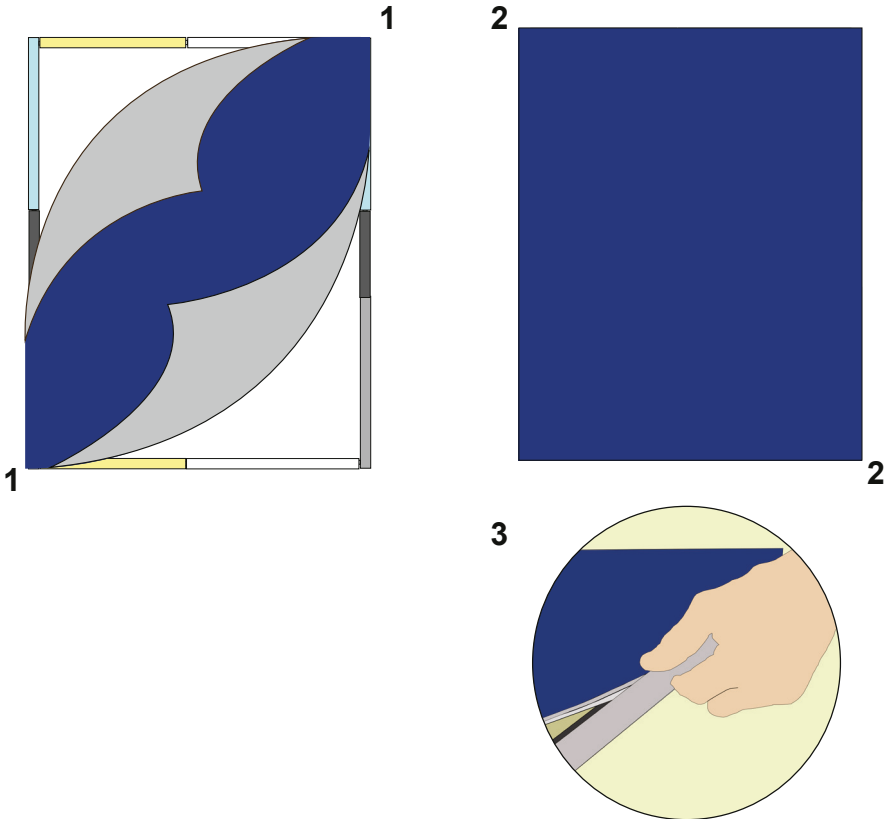

# STABILISING FEET

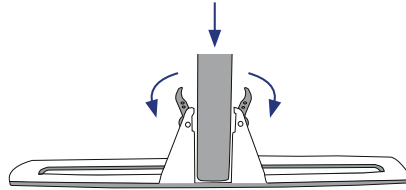

## Standard foot

Double-sided

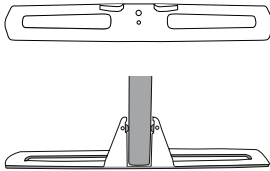

Single-sided

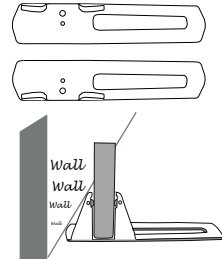

Standard foot      Standard foot

## Connecting foot

Double-sided

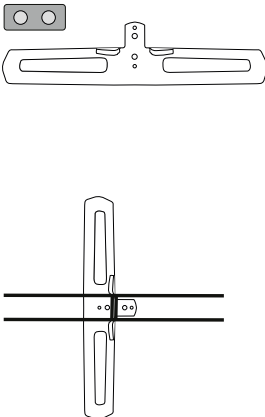

Single-sided

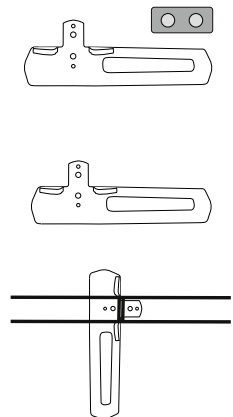

Standard foot      Connecting foot      Standard foot

# CONNECTORS

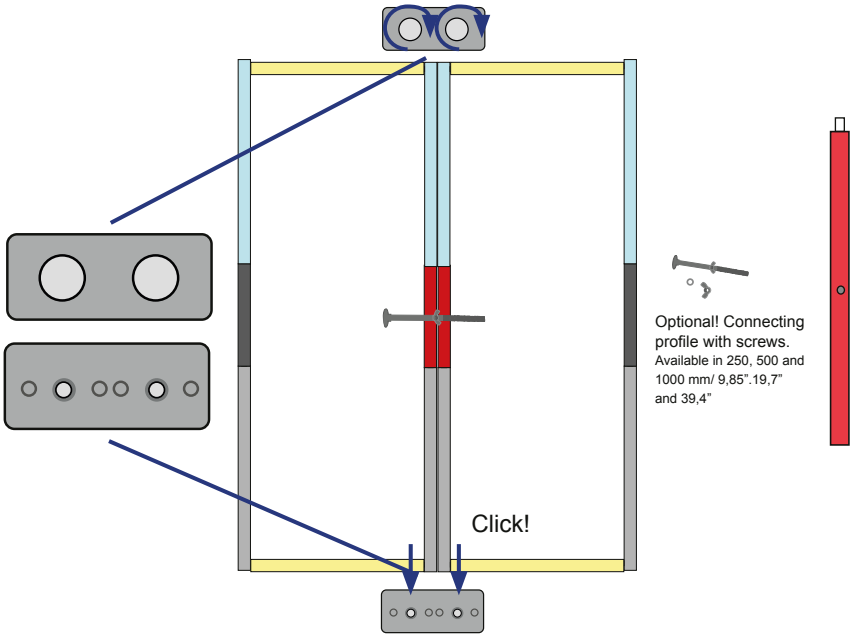

90° type A

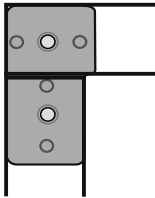

90° type B

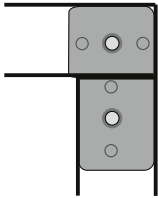

4 way

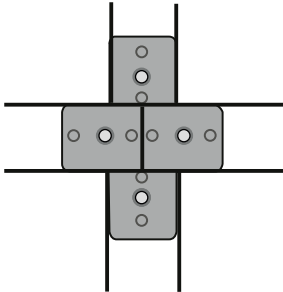

Straight

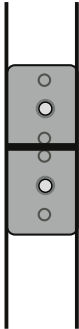

Triple A

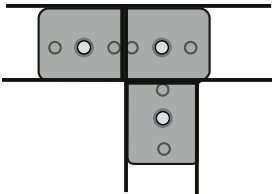

Triple B

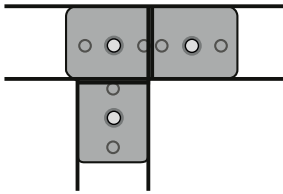

Triple C

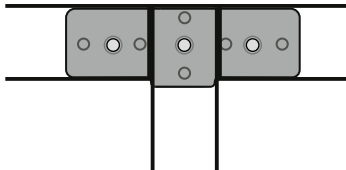

# STORAGE ROOM - right hung door

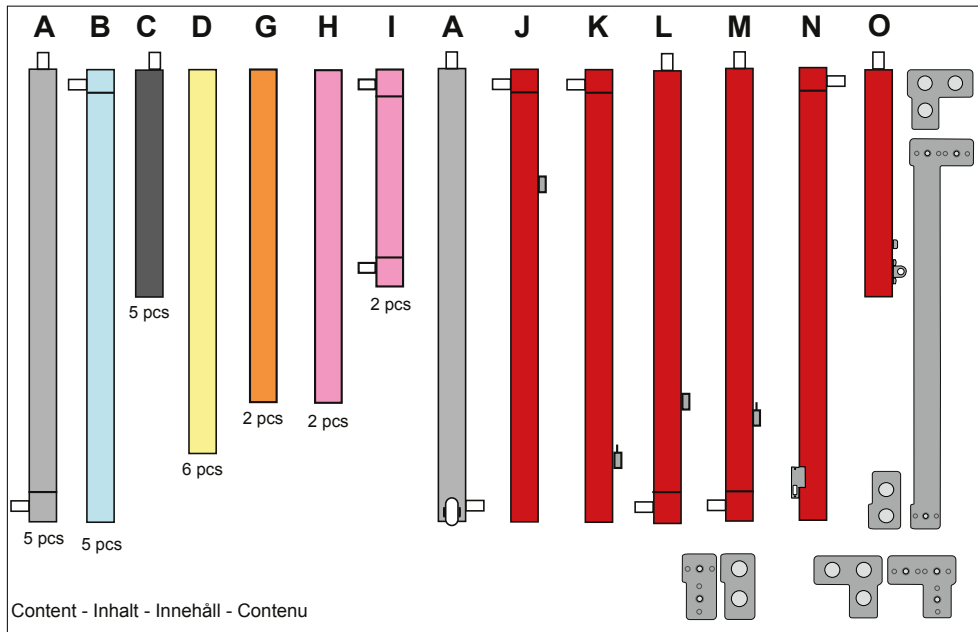

1 - Assemble the 3 side frames

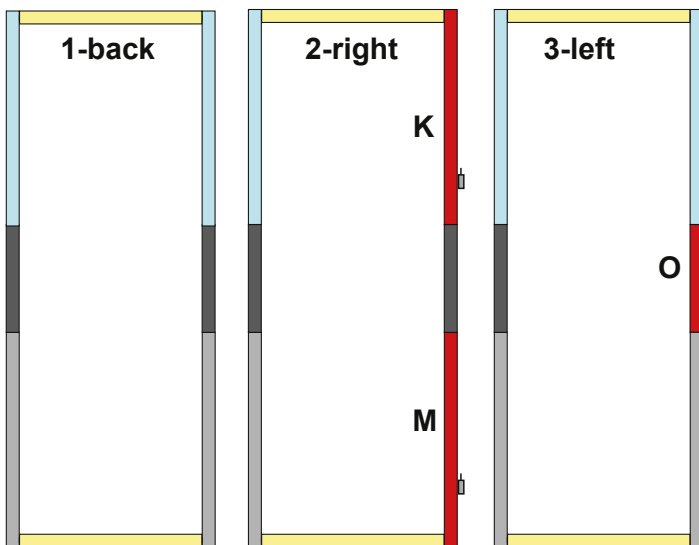

2 - Assemble the header



3 - Assemble the door

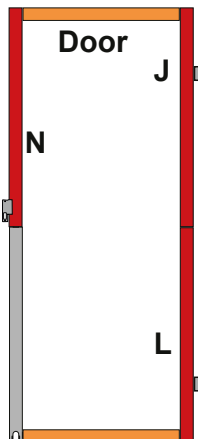

4 - Mount the graphic. **OBS!** If internal graphic is used it must be mounted on frame 1 before going to step 5.

5 - Place on the bottom connectors & threshold

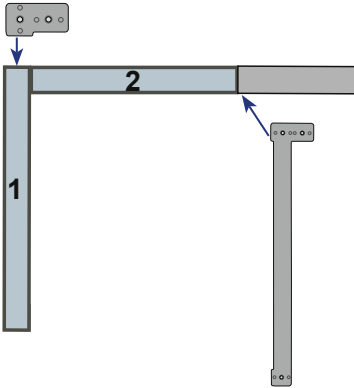

6 - Screw on the top connectors

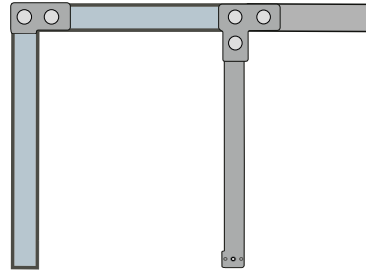

7 - Place on the bottom connector on frame 3

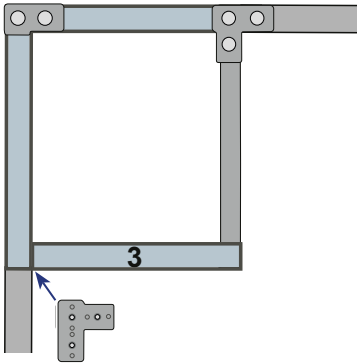

8 - Top connectors + header

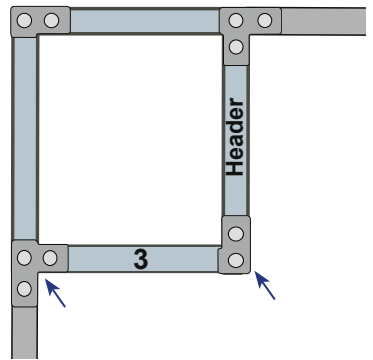

9 - Hang the door on the hinges

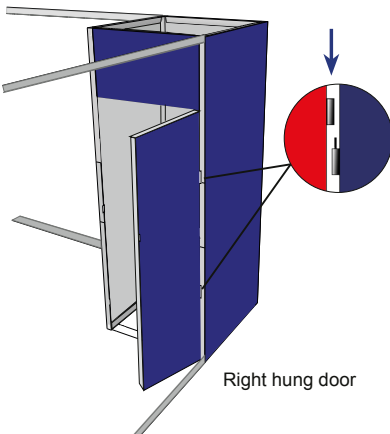

## ACCESSORY - Shelf kit

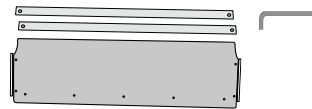

1 - Mount the bars for the internal shelf

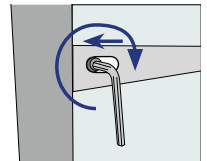

2 - Hang the shelf on the bars

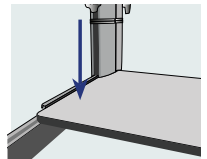

# STORAGE ROOM - left hung door

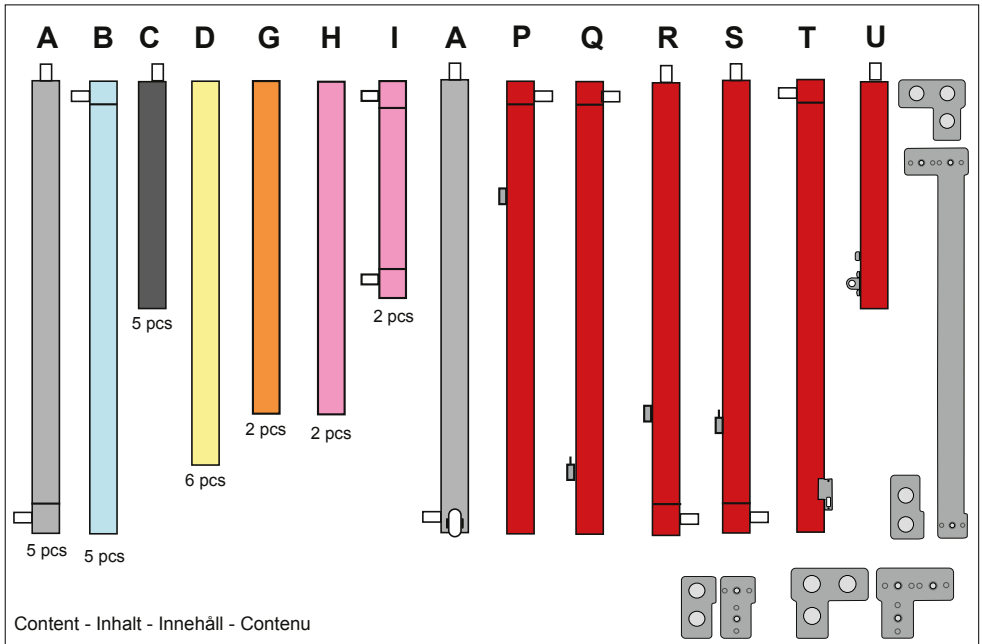

1 - Assemble the 3 side frames

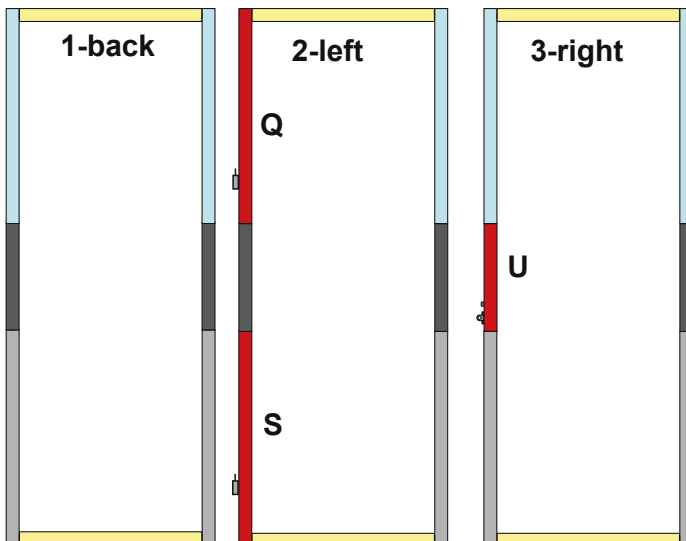

2 - Assemble the header



3 - Assemble the door

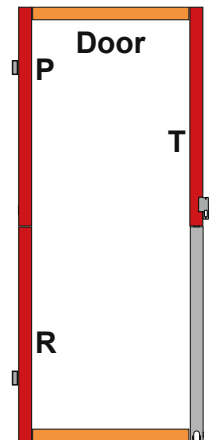

4 - Mount the graphic. **OBS!** If internal graphic is used it must be mounted on frame 1 before going to step 5.



5 - Place on the bottom connectors & threshold

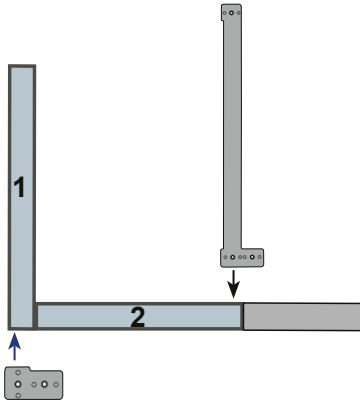

6 - Screw on the top connectors

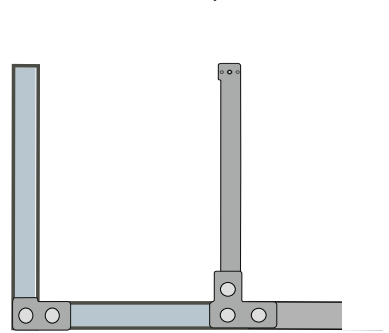

7 - Place on the bottom connector on frame 3

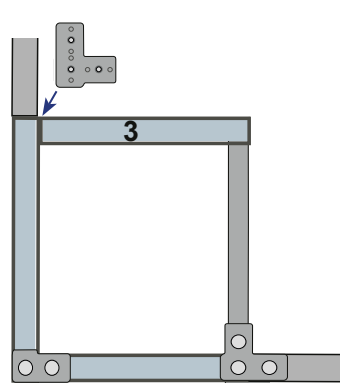

8 - Top connectors + header

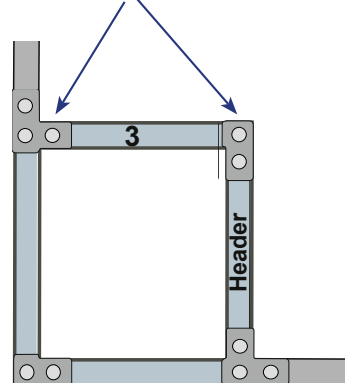

9 - Hang the door on the hinges

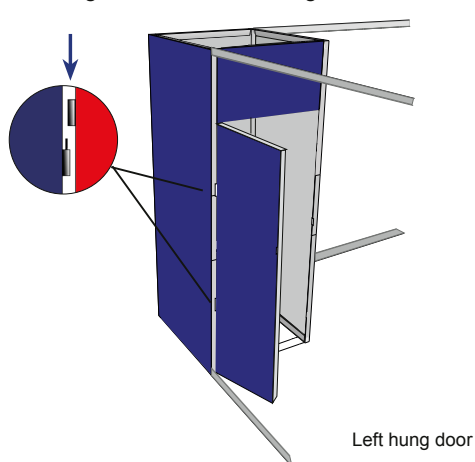

## ACCESSORY - Shelf kit

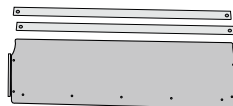

1 - Mount the bars for the internal shelf

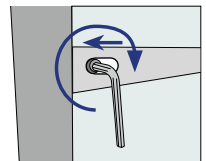

2 - Hang the shelf on the bars

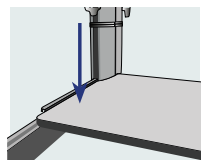



3 - Connect the frames with top and bottom connectors

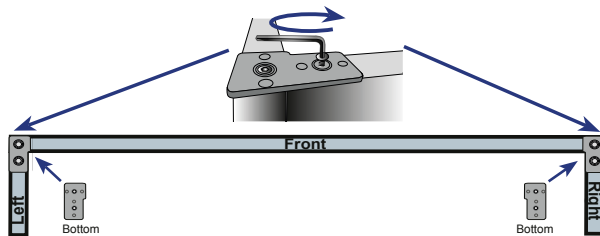

4 - Mount the top shelves and fold down the middle support

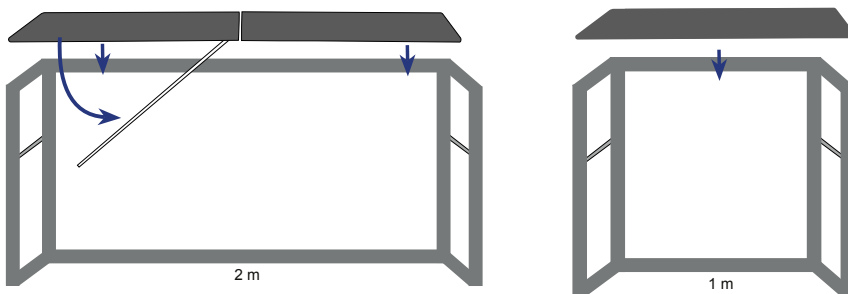

5 - Secure the top shelves

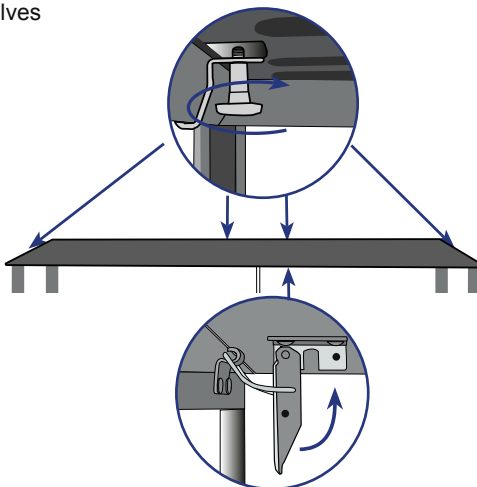

6 - Hang the shelves on the bars

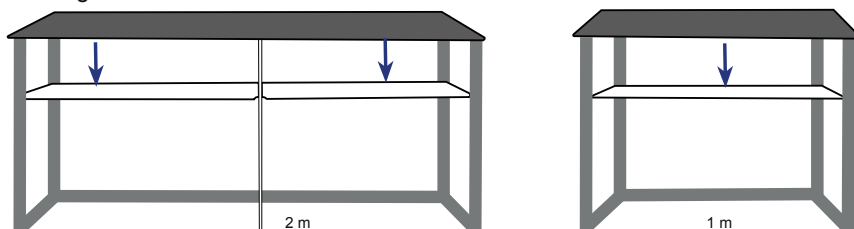

# SPOTLIGHT

